

Chapter 9: Sinusoidal Steady-State Analysis

9.1 The Sinusoidal Source

Sinusoidal source: a source (i or v) that varies sinusoidally with time.

$$v = V_m \cos(\omega t + \phi)$$

Where

V_m is the maximum amplitude

ω is the angular frequency

ϕ is the phase angle

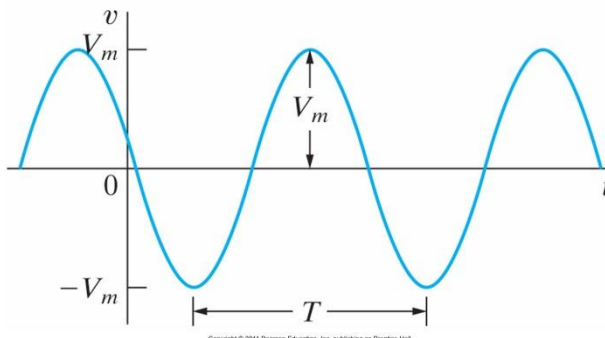

Period (T): the time it takes the sinusoid to pass through all of its possible values; one cycle. Measured in seconds.

Frequency (f): the reciprocal of the period giving the number of cycles per second. Measured in Hertz (Hz).

$$f = \frac{1}{T} = \frac{\omega}{2\pi} \rightarrow \omega = 2\pi f \text{ (radians per second)}$$

Phase angle (ϕ): determines the value of the sinusoid at $t = 0$. Changing the phase angle only shifts the sinusoid on the time axis.

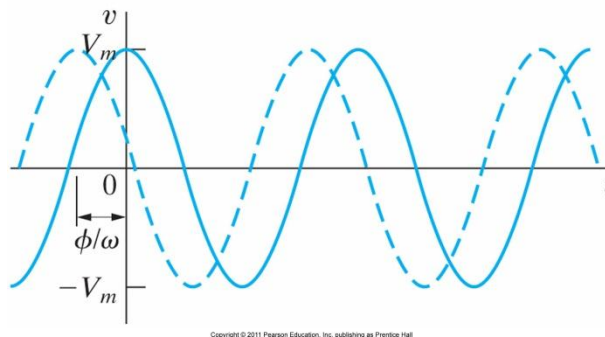

Positive phase angle shifts left negative shifts right.

To convert from radians to degrees:

$$(\text{number of degrees}) = \frac{180^\circ}{\pi} (\text{number of radians})$$

Or

$$2\pi \text{ (radians)} = 360^\circ$$

RMS values: square root of the mean of the square of the function

$$V_{rms} = \sqrt{\frac{1}{T} \int_{t_0}^{t_0+T} V_m^2 \cos^2(\omega t + \phi) dt} = \frac{V_m}{\sqrt{2}}$$

Review Examples 9.1 – 9.4

9.2 The Sinusoidal Response

$$v_s = V_m \cos(\omega t + \phi)$$

KVL

$$L \frac{di}{dt} + iR = V_m \cos(\omega t + \phi)$$

Solving using differential equations

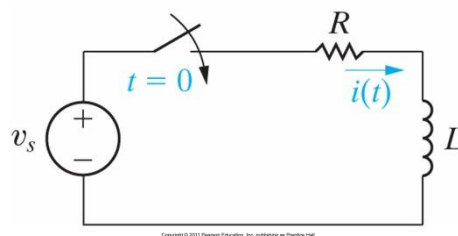

Chapter 9: Sinusoidal Steady-State Analysis

$$i = \frac{-V_m}{\sqrt{R^2 + \omega^2 L^2}} \cos(\phi - \theta) e^{-\frac{R}{L}t} + \frac{V_m}{\sqrt{R^2 + \omega^2 L^2}} \cos(\omega t + \phi - \theta)$$

Where

$$\frac{-V_m}{\sqrt{R^2 + \omega^2 L^2}} \cos(\phi - \theta) e^{-\frac{R}{L}t} \text{ is referred to as the transient component}$$

And

$$\frac{V_m}{\sqrt{R^2 + \omega^2 L^2}} \cos(\omega t + \phi - \theta) \text{ is the steady - state component}$$

Characteristics of the steady-state solution

1. It is a sinusoidal function
2. Frequency of the response is identical to the frequency of the source
3. The maximum amplitude of the response differs from the amplitude of the source
4. The phase angle of the response differs from the phase angle of the source

9.3 The Phasor

Phasor: complex number that carries the magnitude and phase angle information of a sinusoidal function

From Euler's identity:

$$e^{\pm j\theta} = \cos \theta \pm j \sin \theta$$

Where

$$\cos \theta = \Re\{e^{j\theta}\} \quad \text{and} \quad \sin \theta = \Im\{e^{j\theta}\}$$

\Re is the real component and \Im is the imaginary component.

Rewriting a sinusoid

$$v = V_m \cos(\omega t + \phi) = V_m \Re\{e^{j(\omega t + \phi)}\} = V_m \Re\{e^{j\omega t} e^{j\phi}\}$$

Thus the phasor transform

$$\mathbf{V} = V_m e^{j\phi} = \mathcal{P}\{V_m \cos(\omega t + \phi)\}$$

The phasor is usually indicated by bold type or as a variable with an arrow above it \vec{V}

Note: the phasor transform transfers the function from the time domain to the complex number domain known as the frequency domain.

The above transform is in polar coordinate form to express in rectangular form;

$$\mathbf{V} = V_m \cos \phi + jV_m \sin \phi$$

Often the polar expression is further abbreviated as follows

$$V_m e^{j\phi} = V_m \angle \phi^\circ$$

Chapter 9: Sinusoidal Steady-State Analysis

Polar to Rectangular conversion

$$\mathbf{V} = V_m \angle \phi^\circ = V_m \cos \phi + jV_m \sin \phi$$

Rectangular to Polar conversion

$$\mathbf{V} = A + jB = \sqrt{A^2 + B^2} \angle \left(\tan^{-1} \frac{B}{A} \right)^\circ$$

Note: The phasor transform can only be performed on components with the same frequency since the frequency information is not retained in the transform

The Inverse Phasor Transform

$$\mathcal{P}^{-1}\{V_m e^{j\phi}\} = \Re\{e^{j\omega t} e^{j\phi}\}$$

$$ie. \mathbf{V} = 100 \angle -26^\circ \rightarrow v = 100 \cos(\omega t - 26^\circ)$$

The phasor transform is useful in circuit analysis because it reduces the work of finding a steady state response to algebra with complex numbers

Ex.

$$v = v_1 + v_2 + v_3 + \dots \rightarrow \mathbf{V} = \mathbf{V}_1 + \mathbf{V}_2 + \mathbf{V}_3 + \dots$$

Review Example 9.5 and Assessment Problems 9.1 & 9.2

9.4 The Passive Circuit Elements in the Frequency Domain

V-I of Resistors

From Ohm's Law

$$v = R[I_m \cos(\omega t + \phi)] = RI_m \angle \phi = \mathbf{V}$$

$$\mathbf{V} = R\mathbf{I}$$

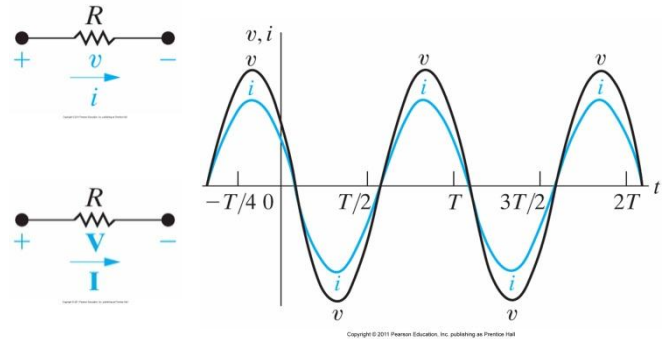

Note: there is no phase shift across the terminals of a resistor

V-I of Inductors

$$\begin{aligned} v &= L \frac{di}{dt} = L[I_m \cos(\omega t + \theta)]' = -\omega LI_m \sin(\omega t + \theta) \\ &= -\omega LI_m \cos(\omega t + \theta - 90^\circ) \end{aligned}$$

$$\begin{aligned} \mathbf{V} &= -\omega LI_m e^{j(\theta - 90^\circ)} = -\omega LI_m e^{-j90^\circ} e^{j\theta} = j\omega LI_m e^{j\theta} \\ &= j\omega L\mathbf{I} \end{aligned}$$

$$\mathbf{V} = (\omega L \angle 90^\circ) I_m \angle \theta = \omega LI_m \angle \theta + 90^\circ$$

Note: there is a +90° phase shift across the terminals of an

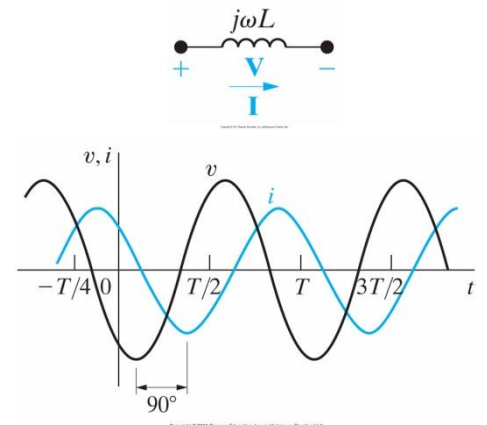

Chapter 9: Sinusoidal Steady-State Analysis

inductor. Voltage *leads* current or current *lags* voltage

V-I of Capacitors

$$i = C \frac{dv}{dt} \rightarrow v = V_m \cos(\omega t + \theta)$$

$$I = j\omega CV$$

$$V = \frac{1}{j\omega C} I$$

$$V = \left(\frac{1}{\omega C} \angle -90^\circ \right) I_m \angle \theta = \frac{I_m}{\omega C} \angle \theta - 90^\circ$$

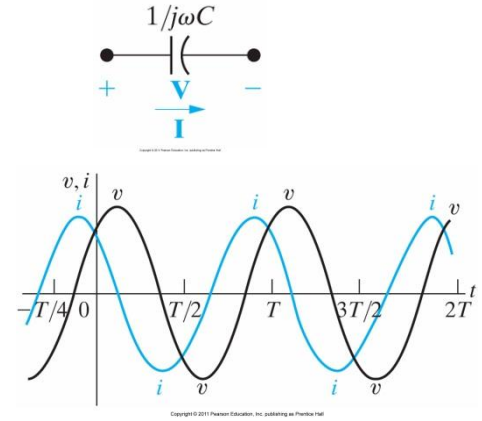

Note: there is a -90° phase shift across the terminals of an inductor. Voltage *lags* current or current *leads* voltage

Impedance and Reactance

Impedance: ratio of a circuit element's voltage phasor to its current phasor.

Reactance: imaginary part of the impedance

In general the V-I characteristic of any element in the frequency domain can be expressed:

$$V = ZI$$

Where Z is the impedance of the circuit element

Note: Although the impedance is a complex number it is not a phasor. Thus all phasors are complex numbers but all complex numbers are not phasors..

Review Assessment Problems 9.3 & 9.4

9.5 Kirchhoff's Laws in the Frequency Domain

KVL in the frequency domain:

$$V_1 + V_2 + \dots + V_n = 0$$

KCL in the frequency domain:

$$I_1 + I_2 + \dots + I_n = 0$$

Thus the techniques used in the time domain are the same for phasors in the frequency domain

Review Assessment Problems 9.5

TABLE 9.1 Impedance and Reactance Values

Circuit Element	Impedance	Reactance
Resistor	R	—
Inductor	$j\omega L$	ωL
Capacitor	$j(-1/\omega C)$	$-1/\omega C$

Copyright © 2011 Pearson Education, Inc. publishing as Prentice Hall

Chapter 9: Sinusoidal Steady-State Analysis

9.6 Series, Parallel and Delta-to-Wye Simplifications

Series impedances combine like series resistances (add up)

Review Example 9.6 and Assessment Problem 9.6

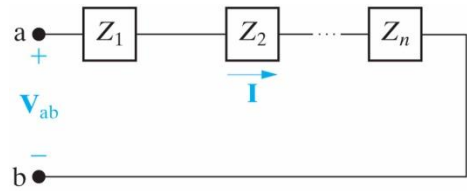

Parallel impedances combine like parallel resistances (inverse of the sum of the inverses)

Review Example 9.7 and Assessment Problems 9.7 & 9.8

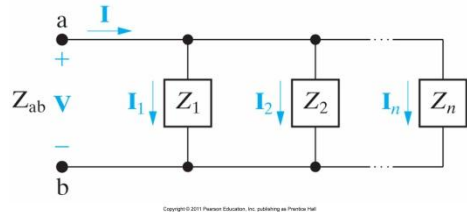

Delta to Wye

$$Z_1 = \frac{Z_b Z_c}{Z_a + Z_b + Z_c} \quad Z_2 = \frac{Z_c Z_a}{Z_a + Z_b + Z_c}$$

$$Z_3 = \frac{Z_a Z_b}{Z_a + Z_b + Z_c}$$

Wye to Delta

$$Z_a = \frac{Z_1 Z_2 + Z_2 Z_3 + Z_3 Z_1}{Z_1}$$

$$Z_b = \frac{Z_1 Z_2 + Z_2 Z_3 + Z_3 Z_1}{Z_2}$$

$$Z_c = \frac{Z_1 Z_2 + Z_2 Z_3 + Z_3 Z_1}{Z_3}$$

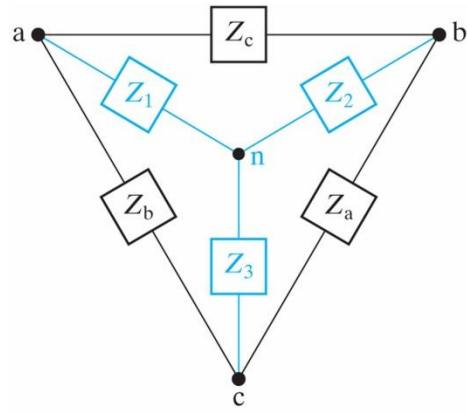

Review Example 9.8 and Assessment Problem 9.9

9.7 Source Transformations and Thevenin-Norton Equivalent Circuits

Source Transformations

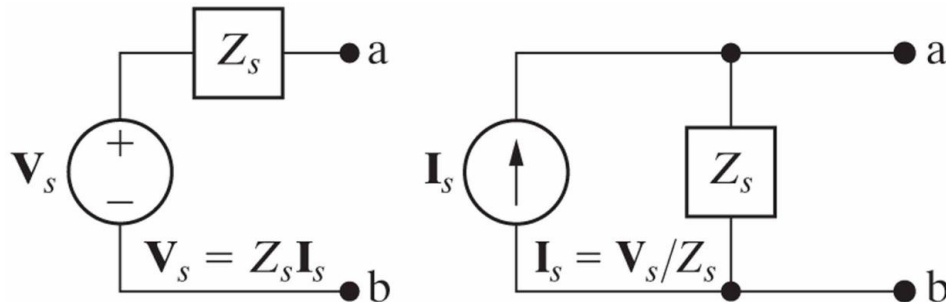

Thevenin and Norton Equivalents

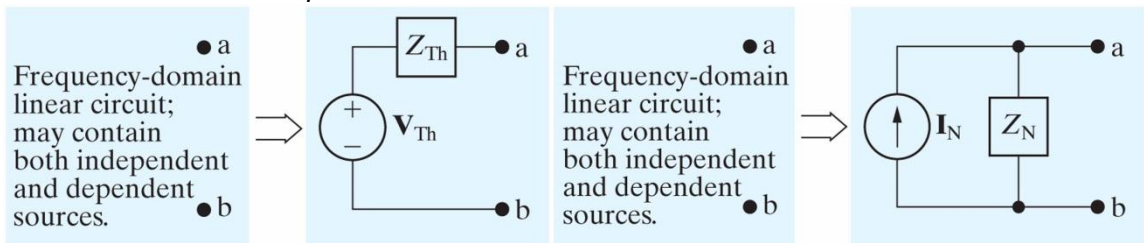

Review Examples 9.9 & 9.10 and Assessment Problems 9.10 & 9.11

Chapter 9: Sinusoidal Steady-State Analysis

9.8 The Node-Voltage Method

Performed the same as in the time domain only on frequency domain equivalent circuits using Impedances

Review Example 9.11 and Assessment Problem 9.12

9.9 The Mesh-Current Method

Performed the same as in the time domain only on frequency domain equivalent circuits using Impedances

Review Example 9.12 and Assessment Problem 9.13

9.10 The Transformer

A device based on magnetic coupling, formed when two coils are wound on a single core. **Linear** transformers are used in communications; **ideal** transformers in power.

Primary winding - side connected to the source

Secondary winding - side connected to the load

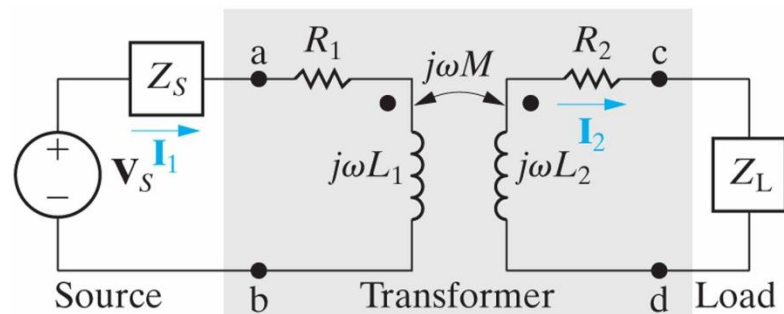

Copyright © 2011 Pearson Education, Inc. publishing as Prentice Hall

Mesh equation of the circuit above

$$V_s = (Z_s + R_1 + j\omega L_1)I_1 - j\omega M I_2$$

$$0 = -j\omega M I_1 + (Z_L + R_2 + j\omega L_2)I_2$$

Substituting: (Z_{11} is the total self-impedance in the primary coil; Z_{22} the secondary coil)

$$Z_{11} = Z_s + R_1 + j\omega L_1$$

$$Z_{22} = Z_L + R_2 + j\omega L_2$$

Solving for the current:

$$I_1 = \frac{Z_{22}}{Z_{11}Z_{22} + \omega^2 M^2} V_s$$

$$I_2 = \frac{j\omega M}{Z_{11}Z_{22} + \omega^2 M^2} V_s = \frac{j\omega M}{Z_{22}} I_1$$

The internal impedance as seen by the source:

Chapter 9: Sinusoidal Steady-State Analysis

$$Z_{int} = \frac{V_s}{I_1} = \frac{Z_{11}Z_{22} + \omega^2 M^2}{Z_{22}} = Z_{11} + \frac{\omega^2 M^2}{Z_{22}}$$

The impedance at the source terminals: $Z_{int} - Z_s$

$$Z_{ab} = Z_{11} + \frac{\omega^2 M^2}{Z_{22}} - Z_s = R_1 + j\omega L_1 + \frac{\omega^2 M^2}{Z_L + R_2 + j\omega L_2}$$

The last term shows effects of the transformer on the load impedance seen by the source. Without a transformer the load would connect directly to the source and the source would see an impedance of Z_L . This term is called the **reflected impedance** (Z_r) and is due solely to the mutual inductance.

Expanding the reflected impedance for $Z_L = R_L + jX_L$

$$Z_r = \frac{\omega^2 M^2}{|Z_{22}|^2} [(R_2 + R_L) - j(\omega L_2 + X_L)]$$

Where $Z_{22} = R_2 + R_L + j(\omega L_2 + X_L)$

9.11 The Ideal Transformer

Transformer exhibiting the following properties:

1. Coefficient of coupling is unity ($k = 1$)
2. The self-inductance of each coil is infinite ($L_1 = L_2 = \infty$)
3. The coil losses, due to parasitic resistance, are negligible

Transformers wound on ferromagnetic cores near this condition.

Determining Voltage and Current Ratios

From the first figure:

$$V_2 = j\omega M I_1$$

$$I_1 = \frac{V_1}{j\omega L_1}$$

Combining the two

$$V_2 = \frac{M}{L_1} V_1$$

For unity coupling

$$M = \sqrt{L_1 L_2}$$

$$V_2 = \sqrt{\frac{L_2}{L_1}} V_1;$$

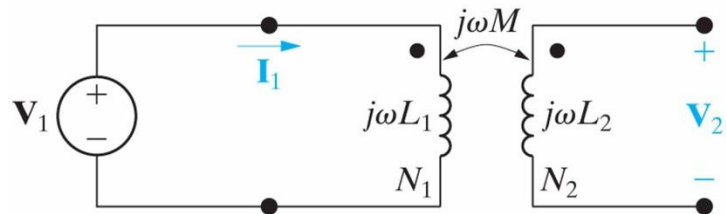

(a)

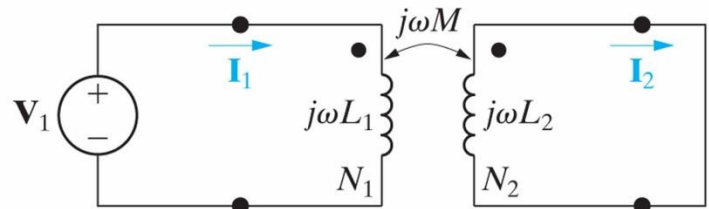

(b)

Copyright © 2011 Pearson Education, Inc. publishing as Prentice Hall

Chapter 9: Sinusoidal Steady-State Analysis

$$\mathbf{V}_2 = \sqrt{\frac{N_2^2 \phi}{N_1^2 \phi}} \mathbf{V}_1 = \frac{N_2}{N_1} \mathbf{V}_1$$

Therefore

$$\frac{\mathbf{V}_1}{N_1} = \frac{\mathbf{V}_2}{N_2}$$

Summing the voltages for the second circuit:

$$0 = -j\omega M \mathbf{I}_1 + j\omega L_2 \mathbf{I}_2$$

$$\frac{\mathbf{I}_1}{\mathbf{I}_2} = \frac{L_2}{M} = \frac{L_2}{\sqrt{L_1 L_2}} = \frac{N_2}{N_1}$$

Therefore

$$\mathbf{I}_1 N_1 = \mathbf{I}_2 N_2$$

Determining the Polarity of the Voltage and Current Ratios

If the coil voltages \mathbf{V}_1 and \mathbf{V}_2 are both positive or negative at the dot-marked terminals, use a plus sign relating the voltages. Otherwise use a negative sign.

If the coil currents \mathbf{I}_1 and \mathbf{I}_2 are both directed into or out of the dot-marked terminals, use a minus sign relating the currents. Otherwise use a plus sign.

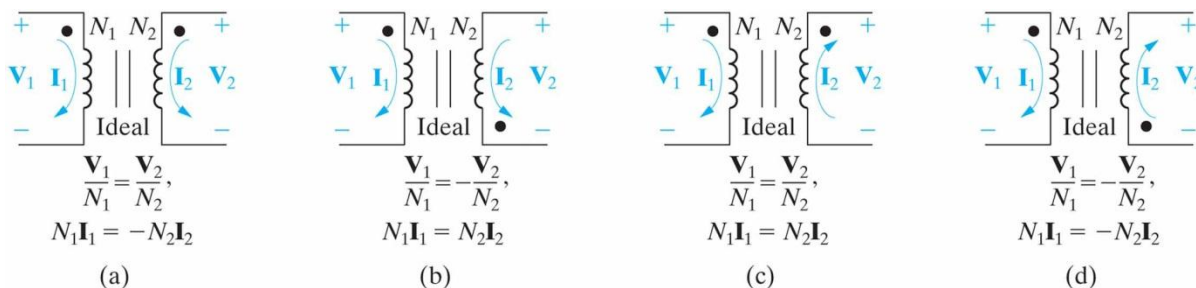

Copyright © 2011 Pearson Education, Inc. publishing as Prentice Hall

Note: The turns-ratio can either be defined as $\frac{N_1}{N_2}$ or $\frac{N_2}{N_1}$; this book uses the later and defines $a = \frac{N_2}{N_1}$

The Use of the Ideal Transformer for Impedance Matching

Using the turns ratio

$$\mathbf{V}_1 = \frac{\mathbf{V}_2}{a} \quad \text{and} \quad \mathbf{I}_1 = a \mathbf{I}_2$$

The impedance seen by the source

$$Z_{in} = \frac{\mathbf{V}_1}{\mathbf{I}_1} = \frac{1}{a^2} \frac{\mathbf{V}_2}{\mathbf{I}_2}$$

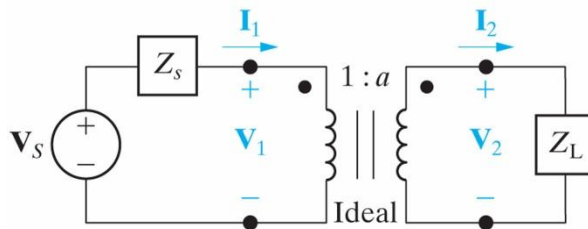

Copyright © 2011 Pearson Education, Inc. publishing as Prentice Hall

Chapter 9: Sinusoidal Steady-State Analysis

9.12 Phasor Diagrams

Plotting a group of phasors:
(Magnitude and phase)

$$\begin{aligned}10 \angle 30^\circ \\ 12 \angle 150^\circ \\ 8 \angle -170^\circ \\ 5 \angle -45^\circ\end{aligned}$$

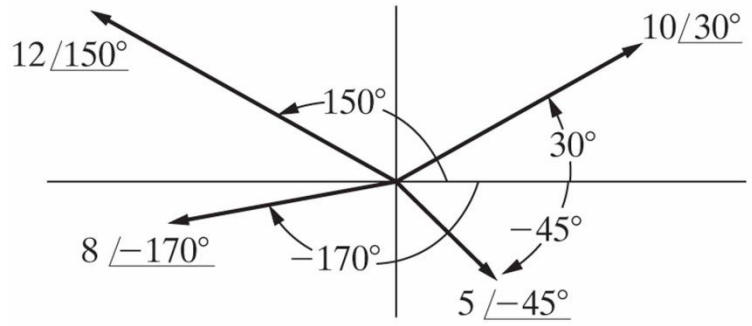

Comparing complex axis to
polar

$$-7 - j3 = 7.62 \angle -156.8^\circ$$

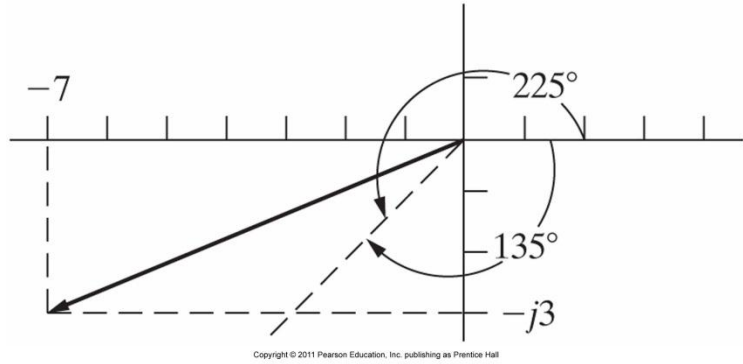

Review Examples 9.15 & 9.16